

Triacs high noise immunity

BT139B series H

GENERAL DESCRIPTION

Glass passivated triacs in a plastic envelope suitable for surface mounting, intended for use in applications requiring high noise immunity in addition to high, bidirectional blocking voltage capability and thermal cycling performance. Typical applications include motor control, industrial lighting, heating and static switching.

QUICK REFERENCE DATA

| SYMBOL | PARAMETER | MAX. | MAX. | MAX. | UNIT |
|--------------|--------------------------------------|--------------------|--------------------|--------------------|------|
| V_{DRM} | Repetitive peak off-state voltages | 500H 500 | 600H 600 | 800H 800 | V |
| $I_{T(RMS)}$ | RMS on-state current | 16 | 16 | 16 | A |
| I_{TSM} | Non-repetitive peak on-state current | 140 | 140 | 140 | A |

PINNING - SOT404

| PIN | DESCRIPTION |
|-----|-----------------|
| 1 | main terminal 1 |
| 2 | main terminal 2 |
| 3 | gate |
| mb | main terminal 2 |

PIN CONFIGURATION

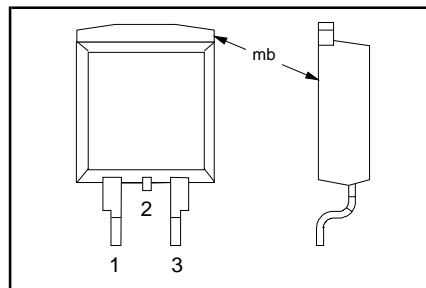

SYMBOL

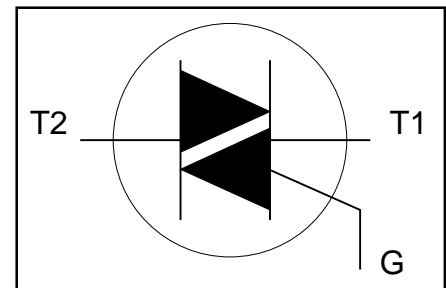

LIMITING VALUES

Limiting values in accordance with the Absolute Maximum System (IEC 134).

| SYMBOL | PARAMETER | CONDITIONS | MIN. | MAX. | | | UNIT |
|--------------|--|---|------|--------------------------|--------------------------|-------------|------------------|
| | | | | -500 500 ¹ | -600 600 ¹ | -800 800 | |
| V_{DRM} | Repetitive peak off-state voltages | | - | | | | V |
| $I_{T(RMS)}$ | RMS on-state current | full sine wave; $T_{mb} \leq 99^\circ\text{C}$ | - | 16 | | | A |
| I_{TSM} | Non-repetitive peak on-state current | full sine wave; $T_j = 25^\circ\text{C}$ prior to surge $t = 20\text{ ms}$ | - | 140 | | | A |
| | | $t = 16.7\text{ ms}$ | - | 150 | | | A |
| I^2t | I^2t for fusing | $t = 10\text{ ms}$ | - | 98 | | | A ² s |
| dl_T/dt | Repetitive rate of rise of on-state current after triggering | $I_{TM} = 20\text{ A}$; $I_G = 0.2\text{ A}$; $dl_G/dt = 0.2\text{ A}/\mu\text{s}$ | | | | | |
| | | T2+ G+ | - | 50 | | | A/ μs |
| | | T2+ G- | - | 50 | | | A/ μs |
| | | T2- G- | - | 50 | | | A/ μs |
| | | T2- G+ | - | 10 | | | A/ μs |
| I_{GM} | Peak gate current | | - | 2 | | | A |
| V_{GM} | Peak gate voltage | | - | 5 | | | V |
| P_{GM} | Peak gate power | | - | 5 | | | W |
| $P_{G(AV)}$ | Average gate power | over any 20 ms period | - | 0.5 | | | W |
| T_{stg} | Storage temperature | | -40 | 150 | | | $^\circ\text{C}$ |
| T_j | Operating junction temperature | | - | 125 | | | $^\circ\text{C}$ |

¹ Although not recommended, off-state voltages up to 800V may be applied without damage, but the triac may switch to the on-state. The rate of rise of current should not exceed 15 A/ μs .

Triacs

high noise immunity

BT139B series H

THERMAL RESISTANCES

| SYMBOL | PARAMETER | CONDITIONS | MIN. | TYP. | MAX. | UNIT |
|----------------|---|------------------------------|------|------|------|------|
| $R_{th\ j-mb}$ | Thermal resistance junction to mounting base | full cycle half cycle | - | - | 1.2 | K/W |
| $R_{th\ j-a}$ | Thermal resistance junction to ambient | minimum footprint, FR4 board | - | 55 | - | K/W |

STATIC CHARACTERISTICS

$T_j = 25\text{ °C}$ unless otherwise stated

| SYMBOL | PARAMETER | CONDITIONS | MIN. | TYP. | MAX. | UNIT |
|----------|---------------------------|---|------|------|------|------|
| I_{GT} | Gate trigger current | $V_D = 12\text{ V}$; $I_T = 0.1\text{ A}$ | | | | |
| | | T2+ G+ | 10 | 14 | 50 | mA |
| | | T2+ G- | 10 | 17 | 50 | mA |
| | | T2- G- | 10 | 18 | 50 | mA |
| | | T2- G+ | 10 | 40 | 100 | mA |
| I_L | Latching current | $V_D = 12\text{ V}$; $I_{GT} = 0.1\text{ A}$ | | | | |
| | | T2+ G+ | - | 10 | 60 | mA |
| | | T2+ G- | - | 25 | 90 | mA |
| | | T2- G- | - | 12 | 60 | mA |
| | | T2- G+ | - | 14 | 90 | mA |
| I_H | Holding current | $V_D = 12\text{ V}$; $I_{GT} = 0.1\text{ A}$ | - | 8 | 60 | mA |
| V_T | On-state voltage | $I_T = 20\text{ A}$ | - | 1.2 | 1.6 | V |
| V_{GT} | Gate trigger voltage | $V_D = 12\text{ V}$; $I_T = 0.1\text{ A}$ | - | 0.7 | 1.5 | V |
| I_D | Off-state leakage current | $V_D = 400\text{ V}$; $I_T = 0.1\text{ A}$; $T_j = 125\text{ °C}$ | 0.25 | 0.4 | - | V |
| | | $V_D = V_{DRM(max)}$; $T_j = 125\text{ °C}$ | - | 0.1 | 0.5 | mA |

DYNAMIC CHARACTERISTICS

$T_j = 25\text{ °C}$ unless otherwise stated

| SYMBOL | PARAMETER | CONDITIONS | MIN. | TYP. | MAX. | UNIT |
|---------------|---|--|------|------|------|------------|
| dV_D/dt | Critical rate of rise of off-state voltage | $V_{DM} = 67\% V_{DRM(max)}$; $T_j = 125\text{ °C}$; exponential waveform; gate open circuit | 200 | 500 | - | V/ μ s |
| dV_{com}/dt | Critical rate of change of commutating voltage | $V_{DM} = 400\text{ V}$; $T_j = 95\text{ °C}$; $I_{T(RMS)} = 16\text{ A}$; $di_{com}/dt = 7.2\text{ A/ms}$; gate open circuit | 10 | 20 | - | V/ μ s |
| t_{gt} | Gate controlled turn-on time | $I_{TM} = 20\text{ A}$; $V_D = V_{DRM(max)}$; $I_G = 0.1\text{ A}$; $di_G/dt = 5\text{ A}/\mu$ s | - | 2 | - | μ s |

Triacs
high noise immunity

BT139B series H

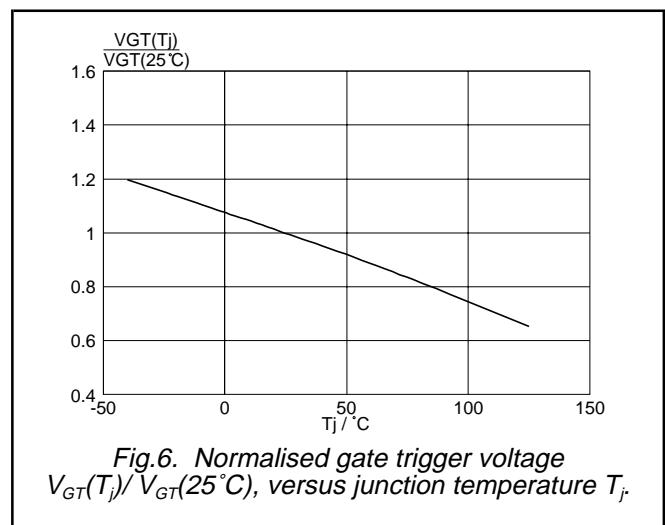
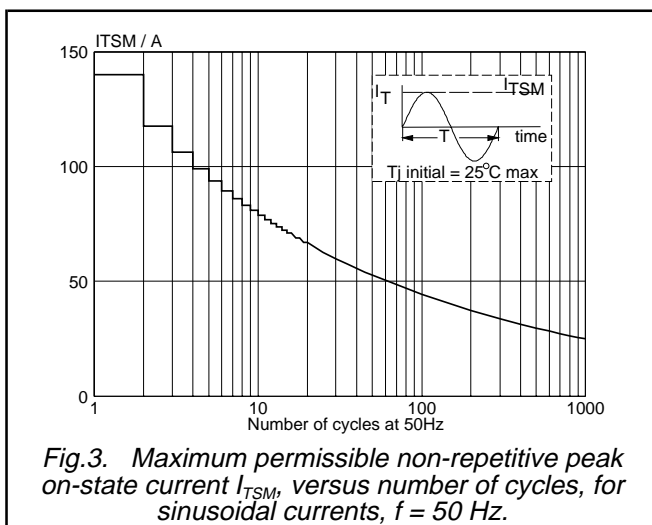
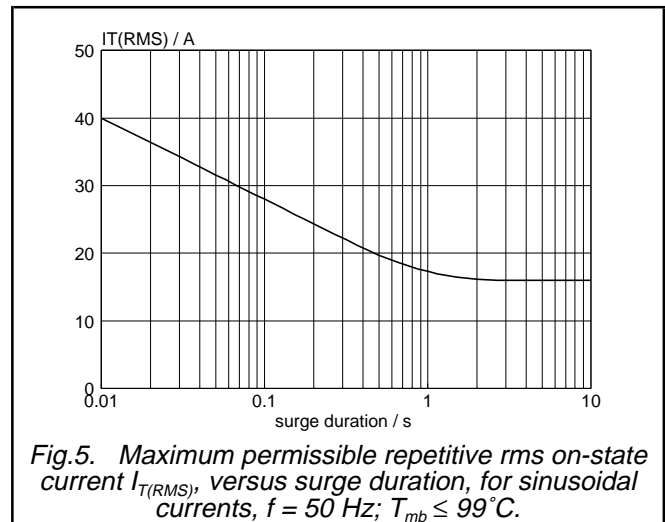
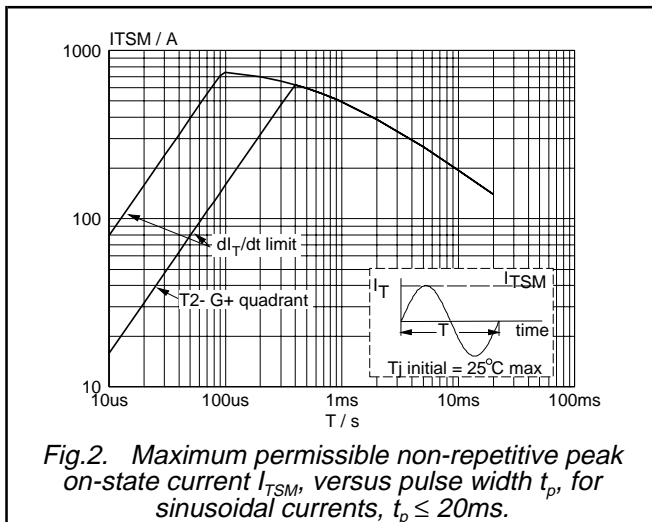
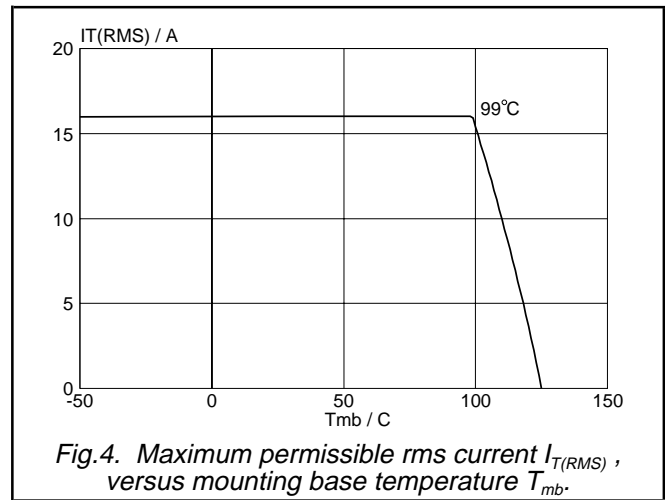
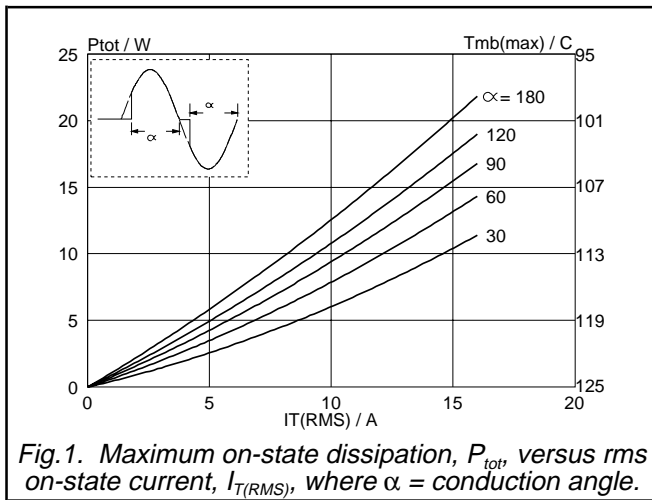

Triacs
high noise immunity

BT139B series H

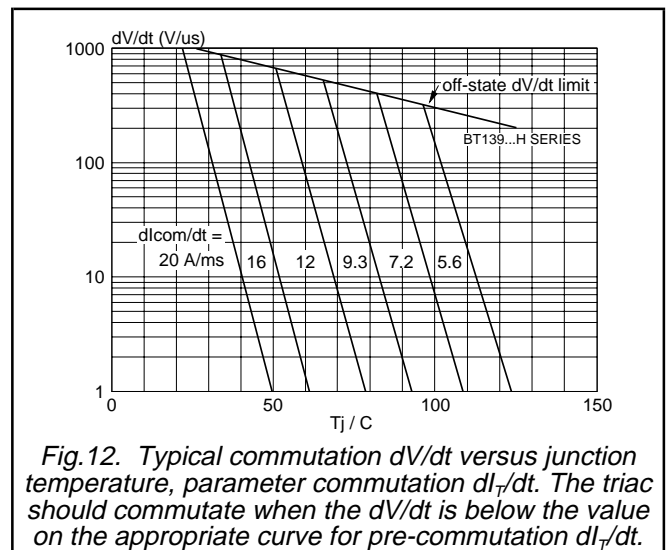
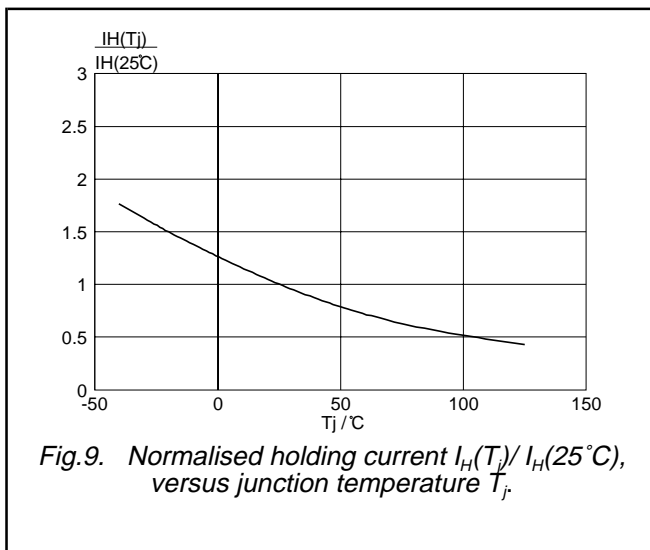
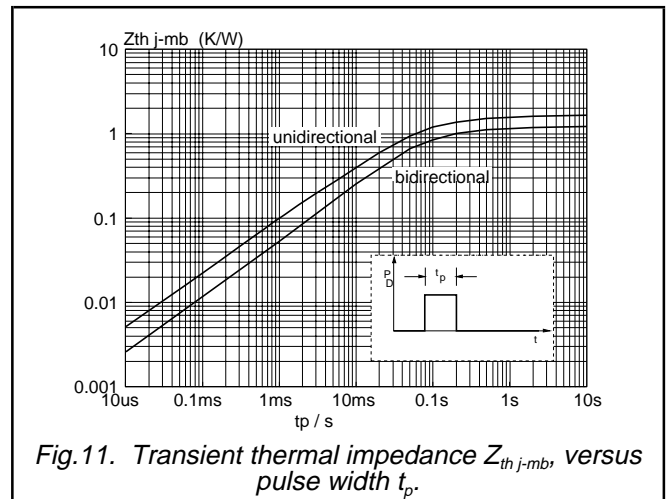
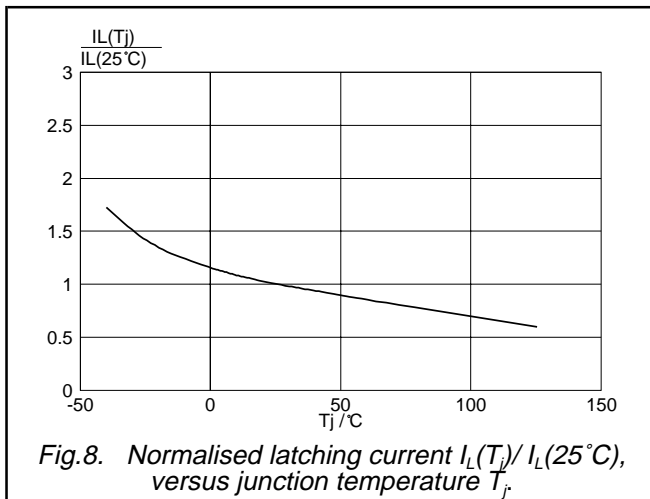
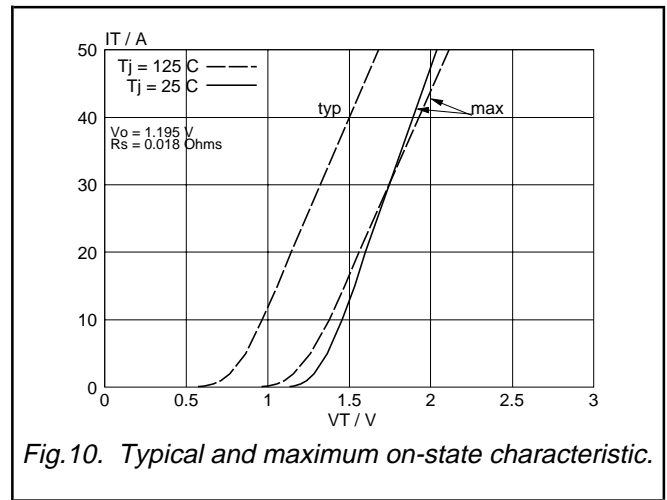
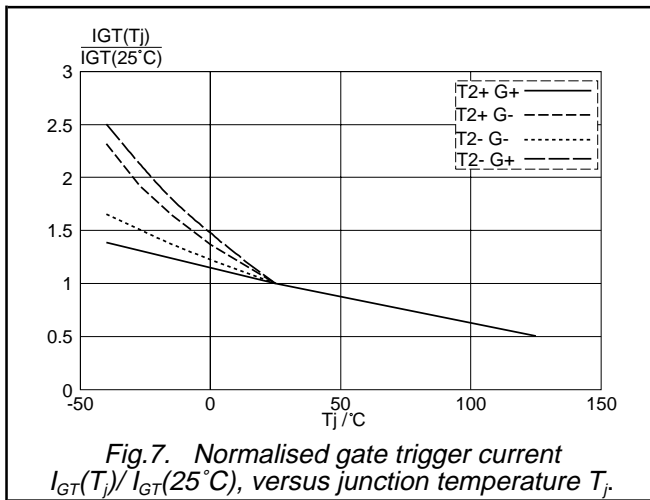

Triacs
high noise immunity

BT139B series H

MECHANICAL DATA

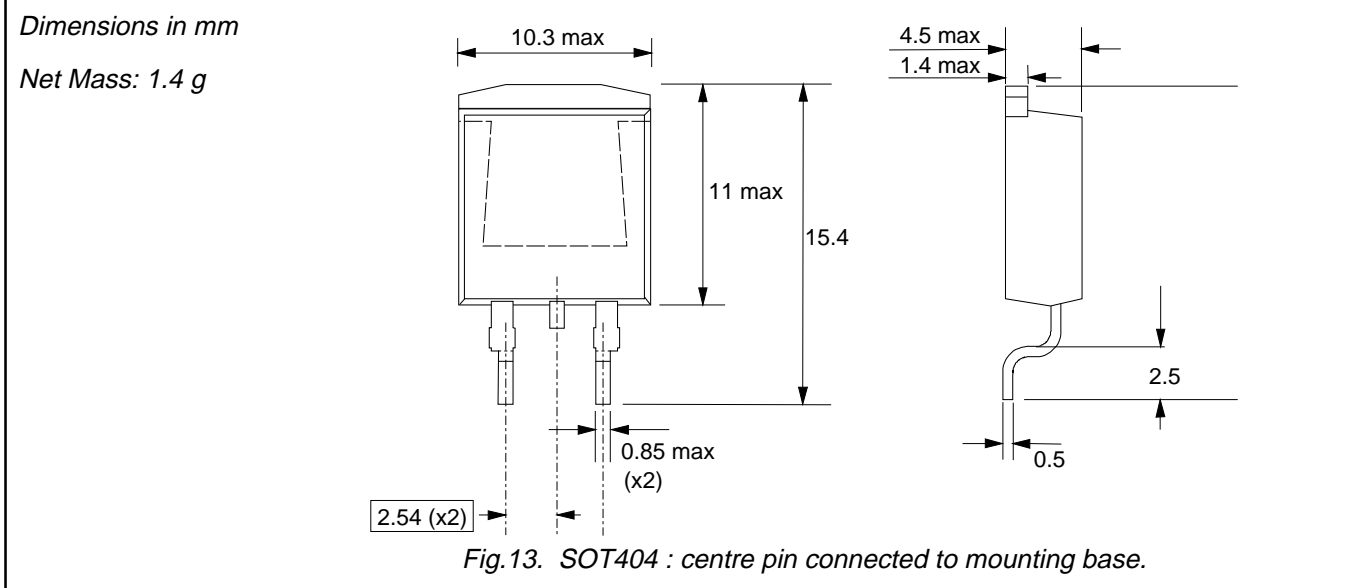

Notes

1. Epoxy meets UL94 V0 at 1/8".

MOUNTING INSTRUCTIONS

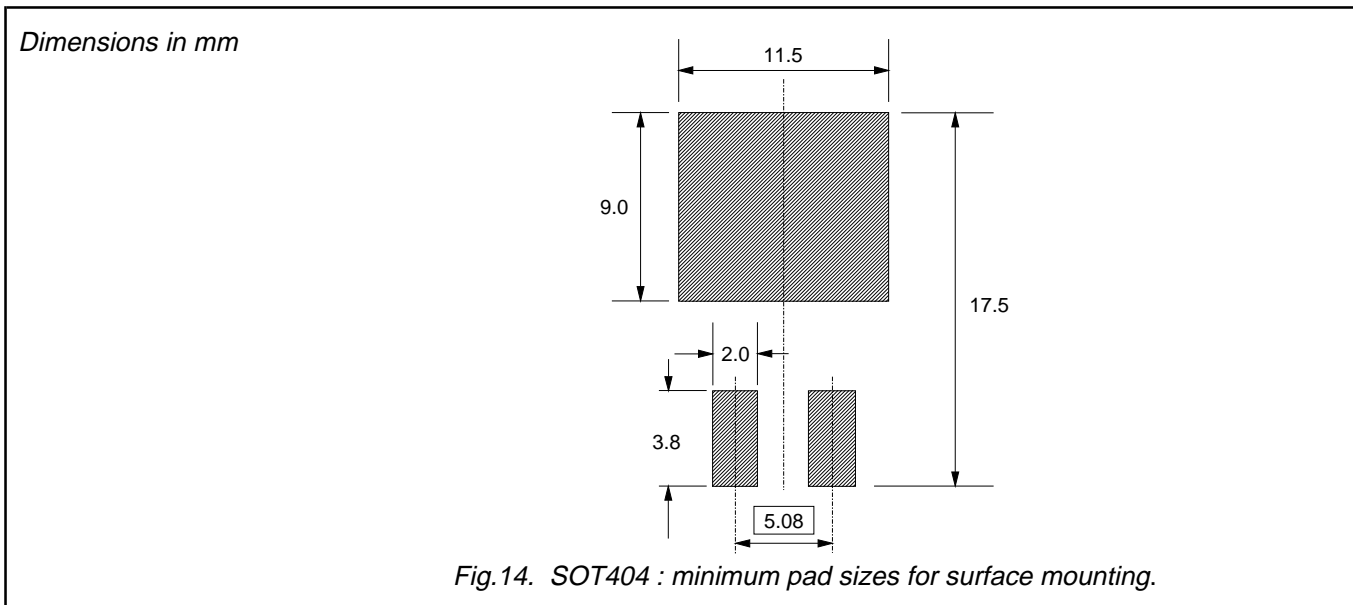

Notes

1. Plastic meets UL94 V0 at 1/8".

Triacs

high noise immunity

BT139B series H

DEFINITIONS

| | |
|--|---|
| Data sheet status | |
| Objective specification | This data sheet contains target or goal specifications for product development. |
| Preliminary specification | This data sheet contains preliminary data; supplementary data may be published later. |
| Product specification | This data sheet contains final product specifications. |
| Limiting values | |
| Limiting values are given in accordance with the Absolute Maximum Rating System (IEC 134). Stress above one or more of the limiting values may cause permanent damage to the device. These are stress ratings only and operation of the device at these or at any other conditions above those given in the Characteristics sections of this specification is not implied. Exposure to limiting values for extended periods may affect device reliability. | |
| Application information | |
| Where application information is given, it is advisory and does not form part of the specification. | |
| © Philips Electronics N.V. 1997 | |
| All rights are reserved. Reproduction in whole or in part is prohibited without the prior written consent of the copyright owner. | |
| The information presented in this document does not form part of any quotation or contract, it is believed to be accurate and reliable and may be changed without notice. No liability will be accepted by the publisher for any consequence of its use. Publication thereof does not convey nor imply any license under patent or other industrial or intellectual property rights. | |

LIFE SUPPORT APPLICATIONS

These products are not designed for use in life support appliances, devices or systems where malfunction of these products can be reasonably expected to result in personal injury. Philips customers using or selling these products for use in such applications do so at their own risk and agree to fully indemnify Philips for any damages resulting from such improper use or sale.